

M-850

**HEXAPOD Six-Axis
Parallel-Kinematics MicroMotion Robot**



M-850 Hexapod 6D MicroMotion Robot

Application Examples

- Alignment of Optics, Electron Guns, Lasers, or Other Directed-Energy Sources
- Microwave Antenna Test Beds
- Surgical Robots
- Micromachining
- Micromanipulation (Life Sciences)
- X-ray Diffraction Measurements
- Semiconductor Handling Systems
- Tool Control for Precision Machining & Manufacturing
- Fine Positioning of Active Secondary Mirror Platforms in High-Resolution Telescopes

Ordering Information

M-850.11
Hexapod 6-Axis MicroMotion Robot with Motion Controller, 0.5 mm/sec

M-850.50
Hexapod 6-Axis MicroMotion Robot with Motion Controller, 8 mm/sec
Optional Optical Power Meters

F-206.00U
Optical Board (vis. range)

F-206.iRU
Optical Board (IR range)

F-361.10
Optical Power Meter, NIST Traceable, 1000 to 1600 nm wavelength

Custom Designs for Volume Buyers

- **Six Degrees of Freedom**
- **Works in any Orientation**
- **No Moving Cables, for Improved Reliability, Ease of Setup and Reduced Friction**
- **Load Capacity 200 kg Vertically, 50 kg Random Orientation**
- **Heavy-Duty, Ultra-High-Resolution Bearings for 24/7 Applications**
- **Repeatability $\pm 1 \mu\text{m}$ (Z) $\pm 2 \mu\text{m}$ (Six-Axis Moves)**
- **To $0.005 \mu\text{m}$ Design Resolution**
- **Significantly Smaller and Stiffer Package than Conventional Multi-Axis Positioners Provides Better Dynamics & Throughput**
- **True Path Control**
- **Linear and Rotary Multi-Axis Scans**
- **PivotAnywhere™ Virtualized Center of Rotation (Pivot Point) Set by Software**
- **Sophisticated, User-Friendly Software and Control Electronics**

The M-850 MicroMotion robot is based on PI's ultra-high-resolution hexapod technology developed for aligning optics in astronomical telescopes a decade ago. It provides six degrees of freedom with $1 \mu\text{m}$ minimum incremental motion (design resolution of individual struts is $0.005 \mu\text{m}$ for the M-850.11) and allows the user to define the center of rotation (pivot point) anywhere inside or outside the system envelope by one simple software command. Rotation about that pivot point can be specified

(with microradian resolution) for any axis of rotation.

The M-850 Hexapod is of great value for any complex, high-accuracy positioning and alignment task where independent motion in six degrees of freedom is required.

Working Principle

The M-850 Hexapod consists of six struts which expand and contract between a bottom and a top platform. Similar in geometry to positioning systems used in flight simulators, it is the first commercially available system to introduce this design to sub-micron-resolution positioning.

The use of extremely stiff and accurate components for all moving parts, such as joints, bearings and drive screws, results in an unusually high natural frequency (500 Hz @ 10 kg load). Because the six Hexapod struts and the six orthogonal coordinates (X, Y, Z, $\theta_x, \theta_y, \theta_z$) are all interrelated, the twelve strut-end universal joints must guarantee zero backlash and zero runout. To meet this challenge in Hexapod construction, CAD, FEA (finite element analysis) and laser vibrometry were employed for system optimization.

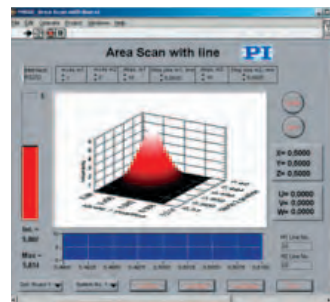

Optical device scan with M-850.50 and F-206.iRU optical power meter

In contrast to conventional multi-axis positioning systems, where a change in one coordinate also affects the pivot point and the other coordinates, the M-850 system **automatically manages its path planning** and the coordination of its six motors and minimizes runout and unwanted motion.

PivotAnywhere™ Virtualized Rotation Capability

A highly useful feature is the M-850's PivotAnywhere™ fully virtualized rotation capability. Hexapod motion is not defined by fixed bearings, but rather by sophisticated real-time 6-space control algorithms. You can define any point in space to be the center of rotation with a single software command. This is ideal for any kind of for angular alignment. All commands and operations are high-level, using human-readable units (mm, degrees) and coordinates (X, Y, Z, $\theta_x, \theta_y, \theta_z$).

Open Interface

Control of the M-850 is facilitated by the controller's open interface architecture which provides a variety of high-level commands for minimized com-

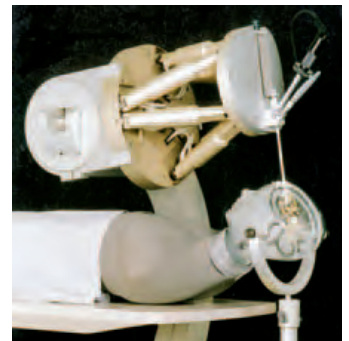

Custom Hexapod for brain surgery. Photo courtesy of IPA

M-840

**HEXALIGHT Fast Six-Axis
Parallel Kinematics Robot (Hexapod)**

**Application
Examples**

- Micromachining
- Micromanipulation
- Life Sciences
- X-ray Diffraction Measurements
- Semiconductor Handling Systems
- Tool Control for Precision Machining & Manufacturing

**Ordering
Information**

M-840.5PD
Hexapod 6-Axis MicroMotion Robot with Motion Controller, Direct Drive

M-840.5DG
Hexapod 6-Axis MicroMotion Robot with Motion Controller, Gearhead Version

Optional Optical Power Meters

F-206.00U
Optical Board (vis. range)

F-206.iRU
Optical Board (IR range)

F-361.10
Optical Power Meter, NIST Traceable, 1000 to 1600 nm Wavelength

**Custom Designs
for Volume Buyers**



M-840 HEXALIGHT 6D micropositioner

- **Six Degrees of Freedom**
- **Fast Step-and-Settle**
- **No Moving Cables for Improved Reliability, Ease of Setup and Reduced Friction**
- **Load Capacity 10 kg**
- **Repeatability to 2 μm (Six-Axis Moves)**
- **Significantly Smaller and Stiffer Package than Conventional Multi-Axis Positioners**
- **Better Dynamics & Throughput**
- **True Path Control**
- **PivotAnywhere™ Virtualized Center of Rotation Set by Software**
- **User-Friendly Software and Control Electronics**

The M-840 HEXALIGHT robot is based on PI's experience in high-resolution parallel kinematic machines (PKM) over more than a decade. PI Hexapods were originally used in astronomical telescopes for mirror and antenna adjustments over wide ranges in

small step sizes. The M-840 provides six degrees of freedom with 3 μm minimum incremental motion (combined 6-axis move, design-resolution of individual struts is 0.016 μm for the M-850.5DG) and allows the user to define the center of rotation (pivot point) anywhere inside or outside the system. The M-840 Hexapod is of great value for any complex, high-accuracy positioning and alignment task where independent motion in six degrees of freedom is required.

Fast Positioning in Space

Compared to the M-850 Hexapods (see page 7-108) the M-840 is built for higher speeds with lower loads. Up to 10 kg in any orientation can be moved at with up to 50 mm/sec (600 mrad/sec) true path control. The control system automatically manages its path planning and the coordination of the six motors and minimizes run-out and unwanted motion.

6-DOF Parallel Machines

The M-840 Hexapod consists of six struts which expand and contract between a bottom and a top platform. All motion in space of the top platform is achieved by changing the length of the individual struts with sub-micron resolution. In contrast to conventional multi-axis positioning systems, where single-axis positioners are stacked upon each other, parallel kinematics systems such as the Hexapod do not exhibit error-summation. Single stage inaccuracies, moving cables of the upper stages, cosine errors due to stack height of the single positioners are all eliminated, and a repeatability in space of a few microns can be achieved. Another big advantage is that with PI Hexapods the center of rotation (pivot point) stays where programmed during all motion.

PivotAnywhere™ Virtualized Rotation Capability

Hexapod motion is not determined by fixed bearings, but rather by sophisticated real-time 6-space control algorithms. For positioning tasks such as alignments, it is important to define a certain point in space as the center of rotation. This point can be chosen freely with a single software command.

Easy Programming Logical Axes and Open Interface

Control of the M-840 is facilitated by the controller's open interface architecture which provides a variety of high-level commands for minimized

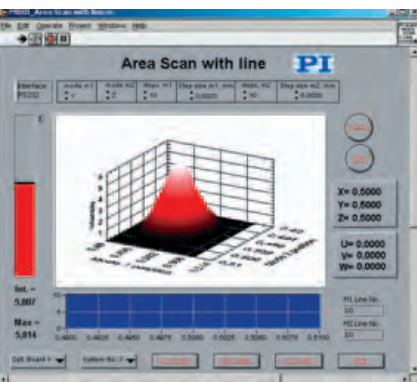

Optical device scan with M-840.5PD and F-206.iRU optical power meter.

For the Latest Product Specs click or go
<http://www.physikinstrumente.com/en/products/index.php>

PZT Actuators
PZT Flexure NanoPositioners
PZT Active Optics / Steering Mirrors
Tutorial: Piezoelectrics...
Capacitive Position Sensors
PZT Control Electronics
MicroPositioners / Hexapod Systems
Photonics Alignment & Packaging Systems
Motor Controllers
Index

<http://www.pi.wi>
info@pi.wi

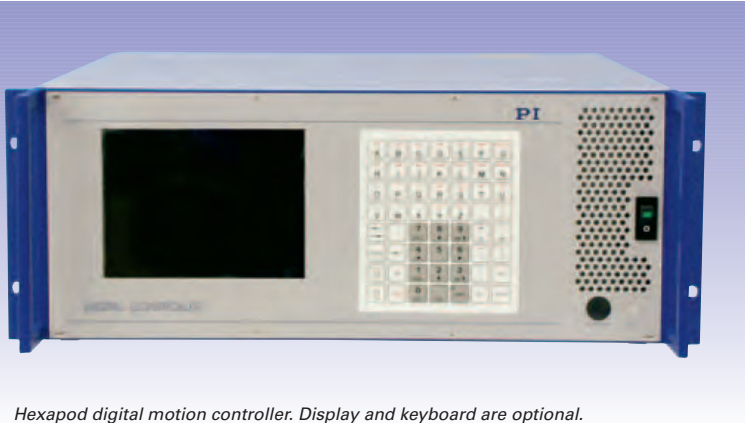

Hexapod digital motion controller. Display and keyboard are optional.



F-361 high-speed optical power meter

communication. The user friendly software and command structure allows direct six-axis positioning by entering Cartesian coordinates X, Y, Z and $\theta_x, \theta_y, \theta_z$.

Automated Optical Alignment

The M-840 can be upgraded with an integrated photometer card (infrared or visible light) for optical alignment and built-in automatic alignment procedures, similar to the compact F-206 HexAlign™ photonics alignment robot (option F-206.IRU or F-206.00U, see p. 8-13). The F-361 high-speed, absolute measuring photometer (see p. 8-32) can also be used with the M-840.

Technical Data

Models	M-840.5PD	M-840.5DG	Units
Travel X,Y**	±50	±50	mm
Travel Z**	±25	±25	mm
Travel $\theta_x, \theta_y, \theta_z$ **	±15	±15	deg
Travel θ_z **	±30	±30	deg
Actuator stroke	±25	±25	mm
Actuator design resolution	0.5	0.016	µm
Min. incremental motion X, Y	3	1	µm*
Min. incremental motion Z	1	0.5	µm*
Min. incremental motion $\theta_x, \theta_y, \theta_z$	5	5	µrad*
Repeatability X, Y	±2	±2	µm
Repeatability Z	±1	±1	µm
Repeatability $\theta_x, \theta_y, \theta_z$	±20	±20	µrad
Typ. velocity X, Y, Z	30	2	mm/sec
Max. velocity X, Y, Z	50	2.5	mm/sec
Typ. velocity $\theta_x, \theta_y, \theta_z$	300	20	mrads
Max. velocity $\theta_x, \theta_y, \theta_z$	600	30	mrads
Load capacity	10	10	kg
Weight	12	12	kg

* simultaneous motion of all 6 actuators. No moving cables. No friction, bending or twisting forces induced by moving cables as with stacked units.

** The travel ranges of the individual coordinates (X, Y, Z, $\theta_x, \theta_y, \theta_z$) are interdependent. The data in this table show maximum travel (where at least one actuator is totally extended). If motion from a particular point or in more than one axis is desired, the available travel may be less.

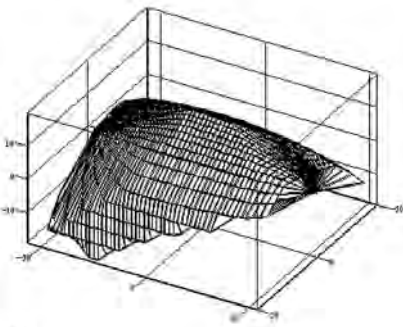

The travel ranges of the individual coordinates (X, Y, Z, $\theta_x, \theta_y, \theta_z$) are interdependent. Resulting working space of the M-840 in X, Y, Z for $\theta_x = \theta_y = \theta_z = 5^\circ$.

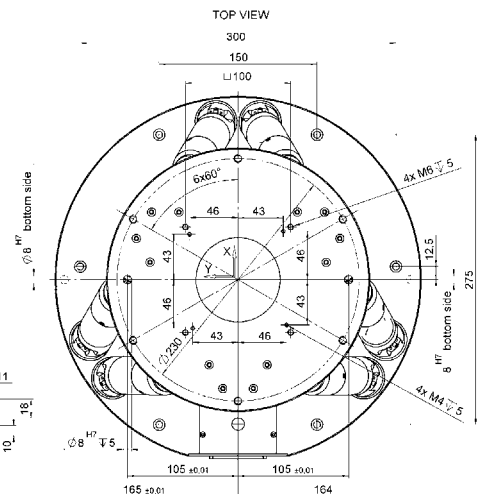
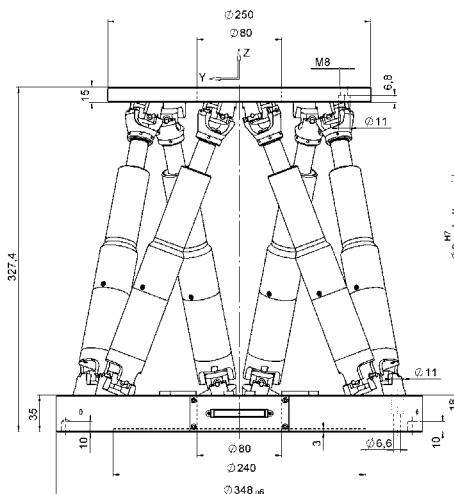

M-840 dimensions in mm.

F-206

HexAlign™ Six-Axis MicroMotion Robot & Alignment System

Ordering Information

- F-206.IR**
HexAlign™ Six-Axis MicroMotion Robot & Alignment System, IR Optical Board
- F-206.00**
HexAlign™ Six-Axis MicroMotion Robot & Alignment System, vis. Optical Board
- F-206.IRD**
HexAlign™ Six-Axis MicroMotion Robot & Alignment System, Front Panel Display & Keyboard, IR Optical Board
- F-206.00D**
HexAlign™ Six-Axis MicroMotion Robot & Alignment System, Front Panel Display & Keyboard, vis. Optical Board

Options & Upgrades (Plug-and-Play, User-Installable)

- F-206.00U**
Optical Board (vis. range)
- F-206.iRU**
Optical Board (IR range)
- F-206.iiU**
2-Channel Photometer Card (IR Range)
- F-206.vvU**
2-Channel Photometer Card (Vis Range)
- F-206.AC8**
Upgrade for 2 Additional Motion-Control Channels on F-206 Controller
- F-206.i3E**
GPIB / IEEE 488 Interface for F-206 Controller
- F-206.MHU**
Force-Limiting Mounting Platform
- F-206.MFU**
Mounting Platform with Force Sensors
- F-206.NCU**
Rapid NanoAlign Upgrade for F-206. Consists of P-611.3SF XYZ NanoAligner, E-760 Controller Board and Alignment Software
- F-206.MC6**
6D Interactive Control Pad
- C-815.MC6**
3 m Extension Cable for Interactive Control Pad
- M-500.206**
Adapter Plate for Mounting F-206 MicroMotion Robots on M-511, M-521 and M-531 Translation Stages (see "Accessories," page 7-82 ff. in the "MicroPositioners" section).

Custom Designs for Volume Buyers

- **Compact, Low-Profile, Six-Axis MicroMotion Robot**
- **PivotAnywhere™ Fully Virtualized Center of Rotation—Pivot About any Point in Space**
- **Automatic Alignment (Transverse and Angular)**
- **Alignment Routines for Collimators and Arrayed Fibers/Components**
- **Digital Controller with Built-in Photometer, or Compatible with External Metrology**
- **High Speed, Fast Settling**
- **No Moving Cables, for Improved Reliability, Easy Setup, Reduced Friction**
- **Automatic Path Planning**
- **Open Source LabView™ Drivers, DLL Libraries...**

6D Alignment

The F-206 HexAlign™ Six-Axis MicroMotion Robot is based on PI's ultra-high-resolution Hexapod technology, developed for aligning optics in astronomical telescopes more than a decade ago. It provides six degrees of freedom, 0.1 μm minimum incremental motion (six-axis move!) and the unique PivotAnywhere™ capability. PivotAnywhere™ allows the user to define the center of rotation (pivot point) anywhere, inside or outside the F-206 workspace envelope, with a single software command.



F-206 HexAlign™ System with Digital Controller (figure shows model F-206.00D with display and keyboard). PI's Hexapod controllers perform sophisticated six-space coordinate transformations and path planning internally, automatically. This makes the systems very easy to use, as the unit speaks in terms of familiar X, Y, Z, θ_x , θ_y , θ_z coordinates with millimeter and degree units (4-decimal-place precision).

Compact, Plug & Play

The F-206 is considerably more compact and accurate than conventional multi-axis systems. Its novel parallel kinematics design (see Principles of Operation, p. 8-9, 8-12)

and powerful, all-digital 6D controller has a vector based design to compensate for unwanted motions.



Parallel kinematics of constant-strut-length Hexapod system shows how little mass (basically only the top platform) has to be supported and moved by the six drives. This explains why the F-206 is considerably faster in terms of step-and-settle than standard "stacked" multi-axis systems, where each stage has to support and move it's own platform and the mass of any other stages above it. Also, note that, unlike serial kinematics systems, there are no moving cables to cause friction, tension or torsion to limit accuracy and repeatability.

PZT Actuators
PZT Flexure NanoPositioners
PZT Active Optics / Steering Mirrors
Tutorial: Piezoelectrics...
Capacitive Position Sensors
PZT Control Electronics
MicroPositioners / Hexapod Systems
Photonics Alignment & Packaging Systems
Motor Controllers
Index

<http://www.pi.ws>
info@pi.ws

Application Examples

- Photonics Packaging
- Optical Device Testing
- Collimator Alignment
- Arrayed Component Alignment
- MEMS Positioning/Alignment
- Fiber Alignment
- Micro-Machining
- Micro-Manipulation (Life Sciences)
- Semiconductor Handling Systems
- Microsurgery

Furthermore, orthogonality and crosstalk issues, which are a formidable assembly and service concern for stacked multi-axis units, do not affect parallel-kinematics systems. There are none of the servo-tuning and dynamic setup procedures necessitated by the widely varying effective loads on stages in a stacked assembly. The F-206 is truly a plug-and-play motion system that requires no servo adjustment or tuning. Its operation is fast and crisp, with uniform dynamics, regardless of the direction of motion. Another advantage of the F-206 design is that there are no moving cables to limit repeatability with friction and no cable management issues to be resolved when integrating the unit.

Working Principle

The basic operating principle of the F-206 is related to the Hexapod principle (PI also offers other types of Hexapod MicroMotion robots, e.g. the M-850, p 7-16). Unlike hexapods with variable-length struts ("legs") the F-206 features constant-length struts. This concept provides the following additional advantages over "classical" variable-strut-length Hexapods:

- Reduced size
- Reduced inertia for improved dynamic performance
- Independent, modular, identical drive/strut units, simplifying assembly and service
- All six struts are driven with individual industrial-class servo-motors and encoders

PivotAnywhere™ Virtualized Rotation

A highly useful feature is the F-206's PivotAnywhere™ fully virtualized rotation capability. Since its motion is not defined by fixed bearings but rather by sophisticated real-time, 6-space control algorithms, you can define any point in space to be the center

of rotation with a **single software command**. This is ideal for angular alignment of collimators or fibers, since it is easy to set the pivot point to

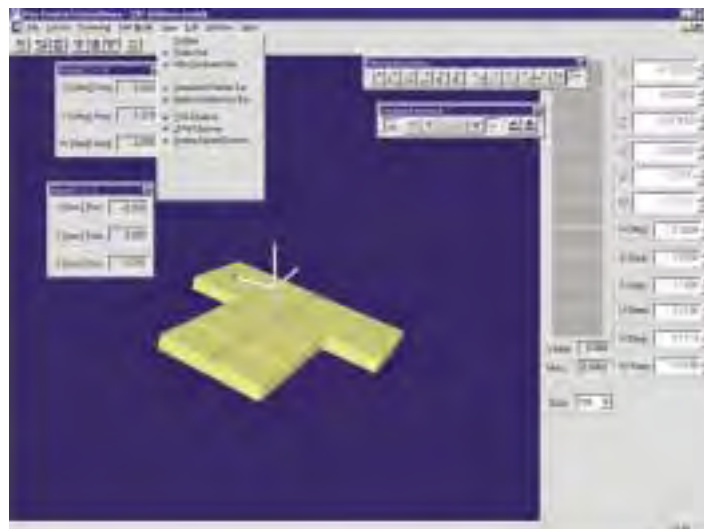

Hex-Control software: manual operation. 3-D view of F-206 platform in space in reference to origin and pivot point.

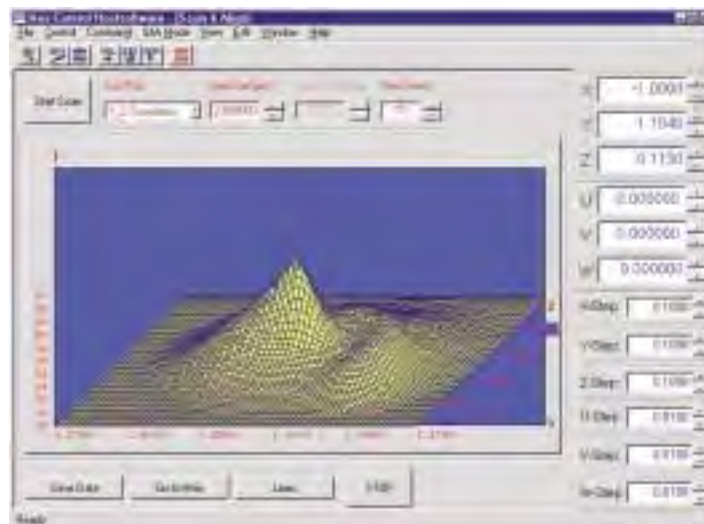

HexControl software. Display shows an optical device scan

F-206

HexAlign™ ... (cont.)

prevent “walking” of the fiber as its tip/tilt orientation is optimized. All commands and operations are high-level, using human-readable units (mm, degrees) and coordinates (X, Y, Z, θ_x , θ_y , θ_z). The F-206 automatically manages its path planning and coordination of its six motors.

Optical Metrology

An integrated photometer card (two, for array alignments, optional) and built-in automatic alignment procedures add to its power in photonics packaging applications.

Software Architecture

Control of the F-206 is facilitated by the controller's software architecture providing a variety of high-level commands for minimized communications overhead & bandwidth.



F-206 HexAlign™ 6D alignment robot combines long-travel, high-precision, six-degree-of-freedom motion and linear/rotary alignment automation. Optional high-speed 100x100x100 μ m, XYZ PZT scanning & alignment module achieves nanometer resolution (see P-611, p. 8-16); F-206.MHU force limiting platform (optional) protects equipment.

Partial Command Listing

MOV X.. Y.. Z.. U.. V.. W
 Move to absolute position (units for X, Y, Z: mm, U, V, W: deg).

SPI R.. S.. T
 Set Pivot Point (with R, S, T in mm).

TAV?
 Tell Analog Value: Reports the voltage at the analog input.

FSC [ax][L][S]
 Execute two dimensional Fast Scan (XY or XZ). The system stops on exceeding the programmed level [L] of the analog input or integrated photometer.

FSA [ax][L][S]
 Fast Scan with Automatic Alignment. On exceeding the Level [L] during the scan, the Automatic Alignment Function is automatically executed.

- Other F-206 features are:**
- Integrated Scan & Automatic Alignment Functions
 - LabView™ Drivers and DLL Libraries
 - Simulation Tools
 - Terminal Software

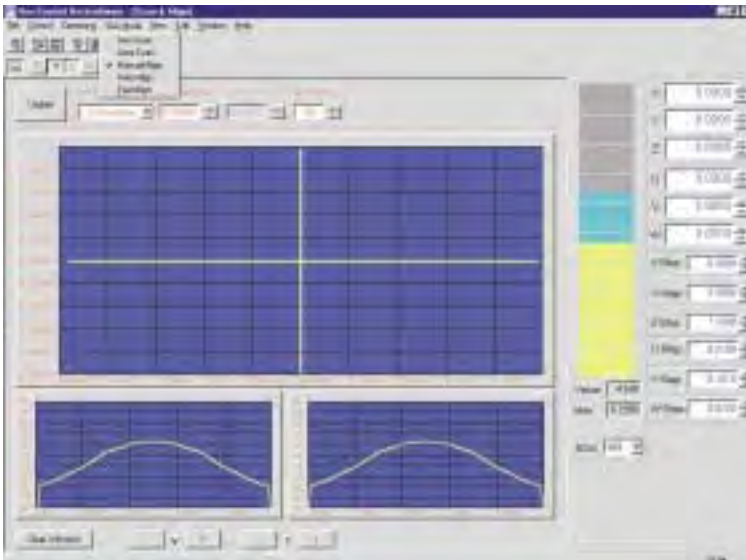

F-206 software even supports manual pre-alignment. The windows show: YZ position, intensity distribution in Y and Z directions and the photometer read-out “thermometer” with peak detector.

For the Latest Product Specs click or go
<http://www.physikinstrumente.com/en/products/index.php>

PZT Actuators
PZT Flexure NanoPositioners
PZT Active Optics / Steering Mirrors
Tutorial: Piezoelectrics...
Capacitive Position Sensors
PZT Control Electronics
MicroPositioners / Hexapod Systems
Photonics Alignment & Packaging Systems
Motor Controllers
Index

<http://www.pi.ws>
info@pi.ws



LabView™ drivers for automated fiber-array alignment are provided with the F-206

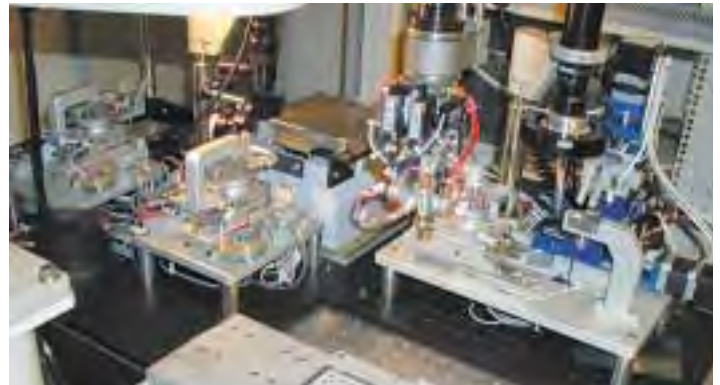

F-206 HexAlign 6-DOF MicroMotion robot deployed as a photonics alignment sub-system for automated assembly of fiber pigtailed devices. Courtesy Aries Innovations

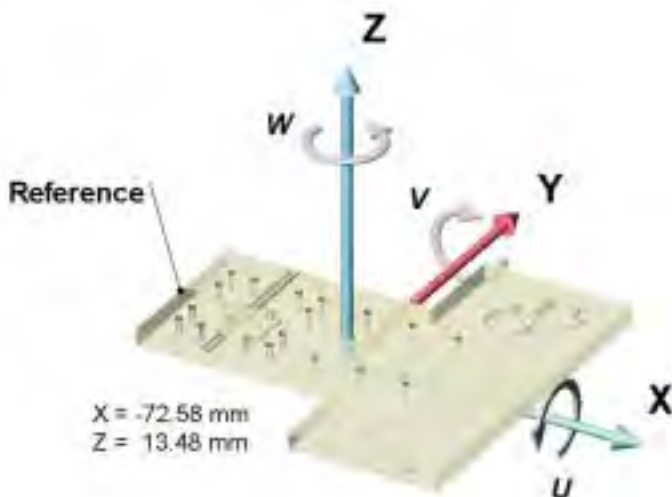

F-206 provides ultra-precise motion in all six degrees of freedom with rotation about any point in space (pivot point set by user)

F-206

HexAlign™ ... (cont.)

F-206 Controller

- **Digital Six-Axis Servo-Controller (6 Axes, + 2 Axes Optional)**
- **Built-in Photometer Card (2nd Card Optional, for Array Alignment)**
- **Built-In High-Speed Analog Input**
- **Wide-Range Power Supply**
- **Optional Interactive Controls (Front Panel Keyboard/ LCD Display)**
- **Optional Interactive Control Pad with Programmable Step Size**
- **Easy Firmware Update**
- **Optional IEEE 488 Interface**
- **Well-Documented, Compact, High-Level Command Set**

The F-206 HexAlign™ controller performs sophisticated six-space coordinate transformations and path planning internally, automatically. This makes the systems very easy to use, as the unit speaks in terms of familiar X, Y, Z, θ_x , θ_y , θ_z coordinates with millimeter and degree units (4-decimal-place precision).

Furthermore, the F-206 controller features a 6+2 architecture, with 6 channels dedicated to control the Hexapod platform. The other two channels (optional) are available for control of other PI motorized equipment, e.g. M-500 series long-travel translation stages, rotation stages, or other actuators for flexible automation.



F-206 Controller, rear view, showing optical fiber input, connectors for motor out, analog in (A/D), power out (servo-amplifiers) and optional monitor out.

PZT Actuators
PZT Flexure NanoPositioners
PZT Active Optics / Steering Mirrors
Tutorial: Piezoelectrics...
Capacitive Position Sensors
PZT Control Electronics
MicroPositioners / Hexapod Systems
Photonics Alignment & Packaging Systems
Motor Controllers
Index

<http://www.pi.ws>
info@pi.ws

Optical Metrology Boards

Standard F-206 systems come with one optical metrology board installed (model number F-206.iR / F-206.iRD for infrared detector or F-206.00 / F-206.00D for visible-light detector). The system can also be upgraded to operate two optical metrology boards for applications such as fully automated fiber-array alignment. See Ordering Information p. 8-8 for upgrade order codes. Two-channel boards are also available.

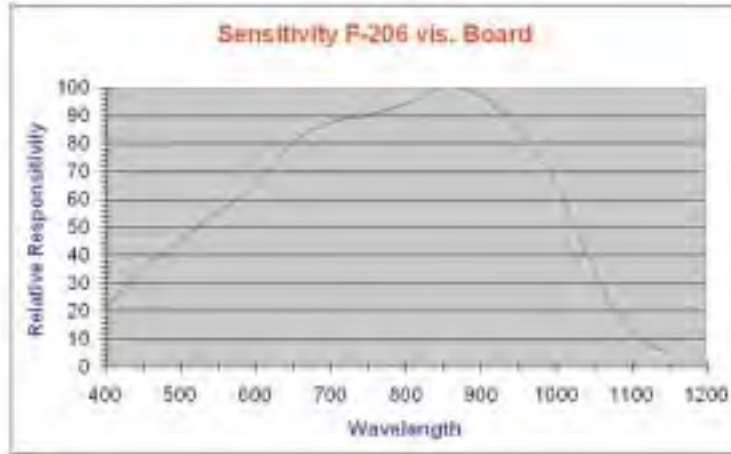

Sensitivity of the visible range photo detector in the F-206 optical metrology board

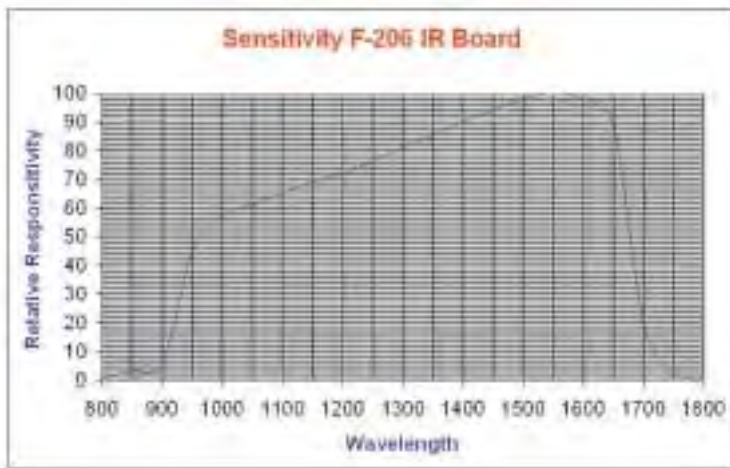

Sensitivity of the IR photo detector in the F-206 optical metrology board



Optical metrology board for the F-206

IR and VIS boards for F-206 Controller

Optical power range:	5 nW – 10 mW
Analog input voltage range:	0 – 10 V
A/D resolution:	12-bit
Sample rate:	10 kHz
Bandwidth:	300 Hz (optical input), 10 kHz (voltage input)
Maximum sensitivity at:	880 nm (VIS); 1550 nm (IR)
40%:sensitivity at	480 / 1040 nm (VIS); 850 / 1680 (IR)

F-206

Upgrades and Options

F-206.MHU, F-206.MFU Force-Limiting, Force-Sensing Platforms



F-206.MHU Magnetic kinematically clamped force limiting platform

In some applications it may be useful to limit the forces on or from the F-206 platform to protect the mechanics or components mounted on the F-206 from damage. Two platform options are available:

F-206.MHU is a magnetic kinematically clamped add-on plat-

form that is automatically released when a certain force or torque is exceeded. This platform also makes it easy to exchange complete setups mounted on different top plates. Additional top plates are available as part number F-206.TMV.

F-206.NCU Rapid NanoAlign Upgrade

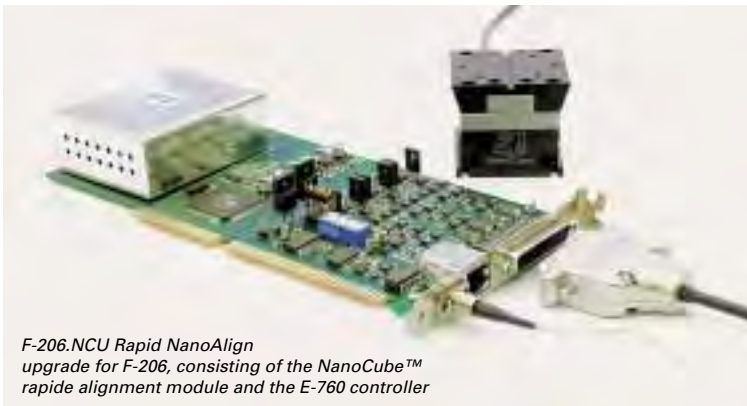

F-206.NCU Rapid NanoAlign upgrade for F-206, consisting of the NanoCube™ rapide alignment module and the E-760 controller

For applications where alignment with nanometer-range resolution is required, or where rapid mapping of the entire cross-coupling area is desired, the F-206.NCU Rapid NanoAlign upgrade is recommended. It consists of a

<http://www.pi.ws>
info@pi.ws

F-206.MFU is similar to F-206.MHU with additional force sensors. The sensor output voltage can be monitored for enhanced safety.

P-611.3SF closed-loop XYZ NanoCube™ alignment module (p. 8-16), the E-760 controller board (p. 6-14), which plugs into the F-206 controller, and special alignment software.

F-206.MC6 6D Interactive Control Pad Upgrade



The F-206.MC6 Interactive control pad upgrade allows fully independent manual moves in each Hexapod axis with software-feedback and variable step size. Works similar to fly-by-wire control in aircraft.

The F-206.MC6 option is a useful addition for simplifying test and setup procedures. It consists of a board that plugs into the F-206 controller and a control pad with six digital “potentiometer” knobs (one for each degree of freedom).

The interactive control pad allows manual step-by-step operation of the platform with a programmable step size. External positioning input (via

the RS-232 interface) can be intermixed with manual positioning input. Both inputs operate on the same position registers of the F-206 controller. The control pad comes with a 3 m cable. A 3 m extension cable is available as part number C-815.MC6.

For Additional Options, see Ordering Information